

User Guide

INSIGNIA™

CD Shelf System with iPod® Dock

NS-ES6112



iPod® is a registered trademark of Apple Computers

Insignia NS-ES6112 CD Shelf System with iPod® Dock

Contents

Introduction	2
Important safety instructions.....	2
Features	4
Setting up your shelf system.....	13
Using your shelf system	18
Troubleshooting	25
Maintaining.....	27
Specifications	28
Legal notices.....	29
One-year limited warranty.....	30

Introduction

Congratulations on your purchase of a high-quality Insignia product. Your NS-ES6112 represents the state of the art in shelf system design and is designed for reliable and trouble-free performance. Your shelf system also includes an iPod® dock that lets you play iPod® songs through your shelf system speakers.

Important safety instructions

- 1 Read these instructions.
- 2 Keep these instructions.
- 3 Heed all warnings.
- 4 Follow all instructions.
- 5 Do not use this apparatus near water.
- 6 Clean only with a dry cloth.
- 7 Do not block any ventilation openings. Install in accordance with the manufacturer's instructions.
- 8 Do not install near any heat sources such as radiators, heat registers, stoves, or other apparatus (including amplifiers) that produce heat.
- 9 Do not defeat the safety purpose of the polarized or grounding-type plug. A polarized plug has two blades with one wider than the other. A grounding type plug has two blades and a third grounding prong. The

wide blade or the third prong are provided for your safety. If the provided plug does not fit into your outlet, consult an electrician for replacement of the obsolete outlet.

- 10 Protect the power cord from being walked on or pinched particularly at plugs, convenience receptacles, and the point where they exit from the apparatus.
- 11 Only use attachments/accessories specified by the manufacturer.
- 12 Use only with the cart, stand, tripod, bracket, or table specified by the manufacturer, or sold with the apparatus. When a cart is used, use caution when moving the cart/apparatus combination to avoid injury from tip-over. 
- 13 Unplug this apparatus during lightning storms or when unused for long periods of time.
- 14 Refer all servicing to qualified service personnel. Servicing is required when the apparatus has been damaged in any way, such as power-supply cord or plug is damaged, liquid has been spilled or objects have fallen into the apparatus, the apparatus has been exposed to rain or moisture, does not operate normally, or has been dropped.
- 15 To reduce the risk of fire or electric shock, do not expose this device to rain, moisture, dripping, or splashing, and no objects filled with liquids, such as vases, shall be placed on it.
- 16 An apparatus with a three-prong, grounding-type plug is a Class I apparatus, which needs to be grounded to prevent possible electric shock. Make sure that you connect this Class I device to a grounding-type, three-prong outlet.
- 17 The wall plug is the disconnecting device. The plug must remain readily operable.
- 18 Batteries should not be exposed to excessive heat such as sunshine, fire, or the like.

Caution

Danger of explosion if battery is incorrectly replaced. Replace only with the same or equivalent type.

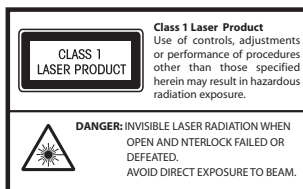

Caution - laser warning

This product employs a laser system. To ensure correct use of this product, read this owner's manual carefully and retain it for future reference. Should your player require maintenance, contact qualified service personnel.

Features**Package contents**



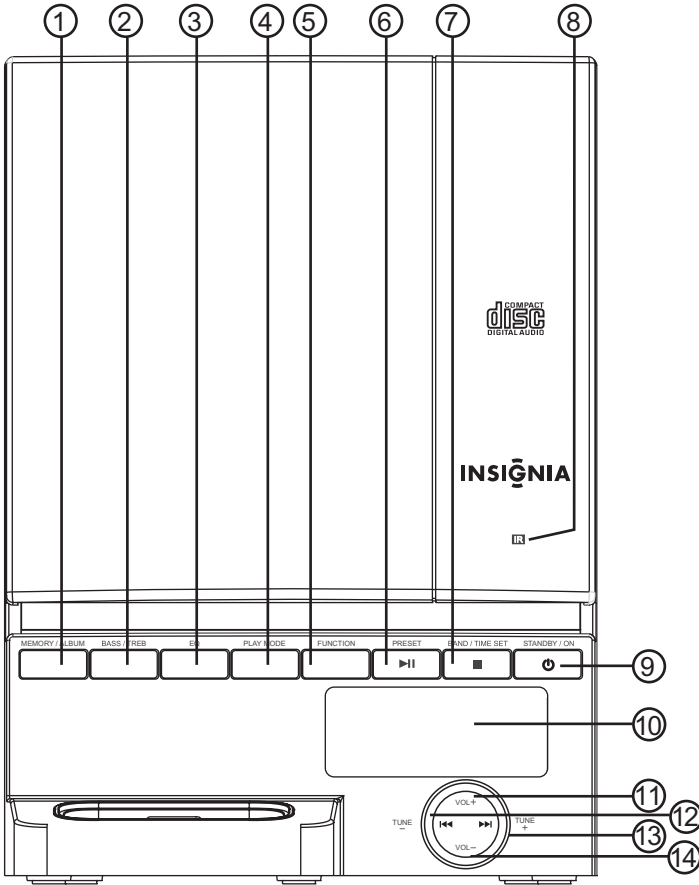

Your shelf system includes the following items:

- Main shelf system unit
- Speakers (2) with speaker wire
- Remote control with CR2025 lithium coin battery
- AC adapter with power cord
- FM dipole antenna
- User Guide
- iPod® dock adapters (6)

Front panel



#	Component	Description
1	MEMORY/ALBUM button	In radio mode, press to store station presets. In MP3/WMA mode, press to go to the next album (folder). Press and hold to skip to the next track in an album.
2	BASS/TREB button	Press to adjust the Bass or Treble.
3	EQ button	Press to select the preset equalizer mode.
4	PLAY MODE button	In CD playback mode, press to cycle through the repeat options. In FM stereo mode, press to select MONO or STEREO .

#	Component	Description
5	FUNCTION button	Press to select the play mode for your shelf system. Choices include AM , FM , CD , iPod® , or Line-in .
6	 (play/pause)/ PRESET button	In playback mode, press to begin playback. Press again to pause playback. Press again to resume playback. In radio mode, press to select a preset station.
7	 (stop)/ BAND/TIME SET button	In playback mode, press to stop playback. In iPod® mode, press to pause playback. In radio mode, press to select AM or FM band. In standby mode, press to set the time.
8	Remote control sensor	Point the remote control at this sensor to control the shelf system.
9	 STANDBY/ON button	Press to turn your shelf system on. Press again to put your shelf system in standby mode.
10	LCD	Displays status information, such as the time, radio band, track number, or playback mode.
11	VOL.+ / ▲ button	Press to increase the volume.
12	 / TUNE- button	In CD or iPod® mode, press to go to the previous track. Hold the button to fast reverse a track. In radio mode, press to seek the previous (lower frequency) radio station. Press and hold to tune to the next lower frequency with a good signal.
13	 / TUNE+ button	In CD or iPod® mode, press to go to the next track. Hold the button to fast forward a track. In radio mode, press to seek the next (higher frequency) radio station. Press and hold to tune to the next higher frequency with a good signal.
14	VOL.- / ▼ button	Press to decrease the volume.

Back panel

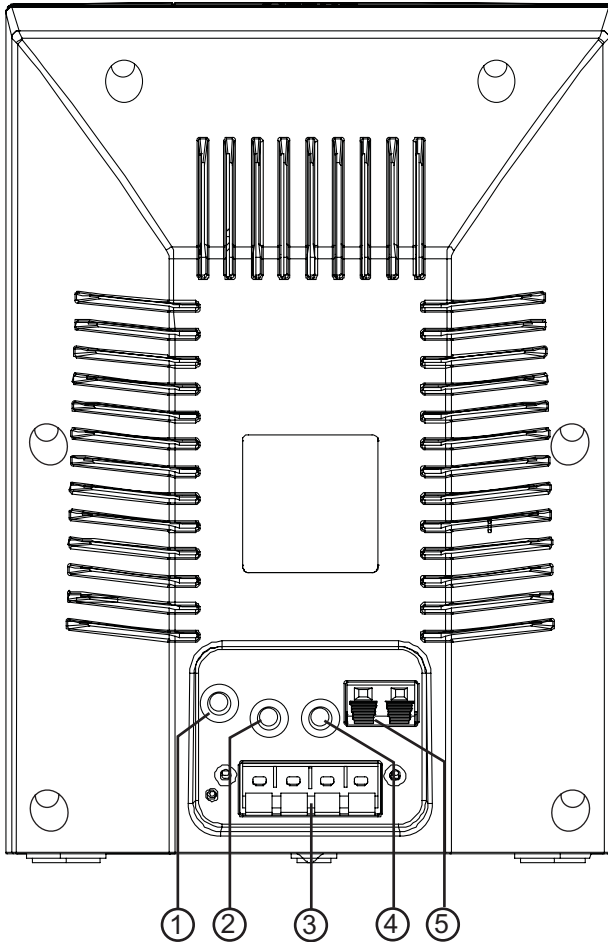

#	Component	Description
1	DC IN 12 V jack	Connect the AC adapter to this jack.
2	LINE IN jack	Plug an external audio device, such as an MP3 player, into this jack to play sound from the device through your shelf system speakers.
3	Speaker jacks	Connect the wires from the left and right speakers to these jacks.

#	Component	Description
4	PHONE jack	Plug headphones into this jack. Note: When headphones are plugged in, no sound comes from the speakers.
5	FM antenna jack	Clip the FM antenna wire to this jack. Extend the antenna to improve the reception of FM broadcasts.

Top panel

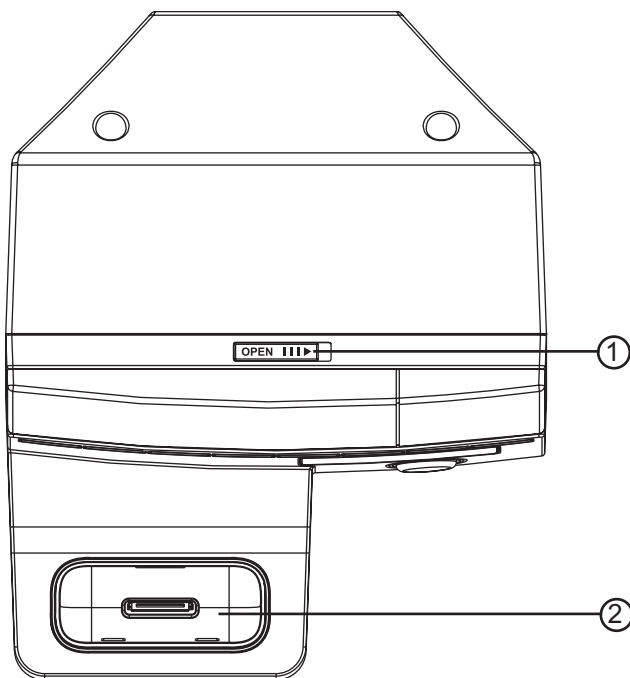

#	Component	Description
1	CD door switch	Press to open the CD door.
2	iPod® dock	Place your iPod® here to connect it to the shelf system. Make sure that you use the correct iPod® dock. For more information, see "Playing an iPod®" on page 19.

Bottom panel

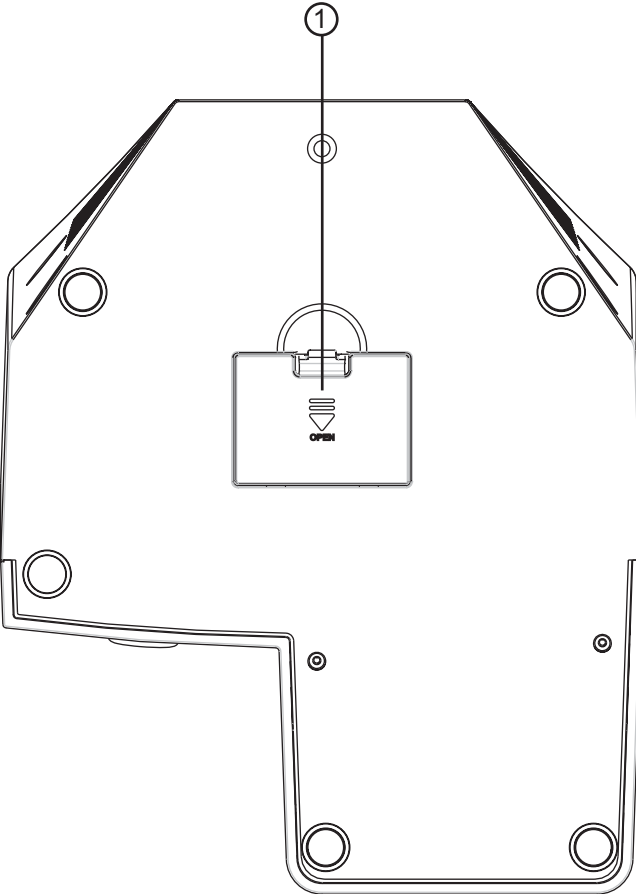

#	Component	Description
1	Clock backup battery compartment	Place a backup battery into this compartment to maintain the correct time and settings if the AC power fails.

Speakers (back)

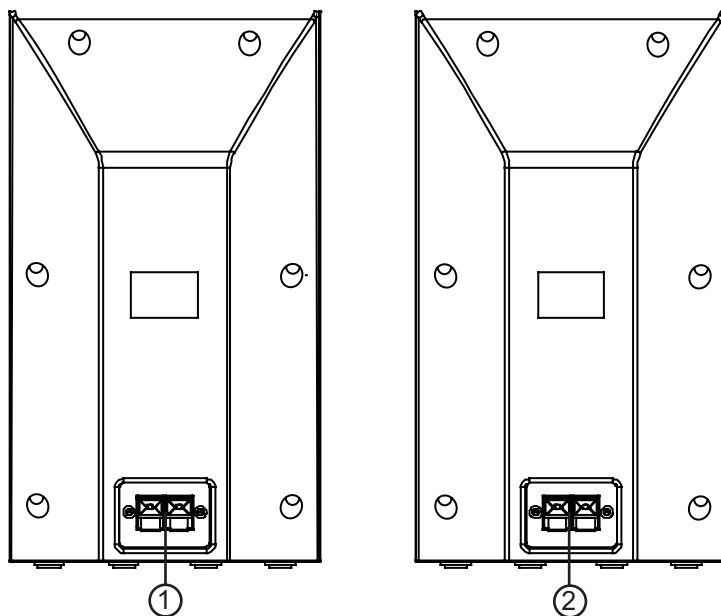

#	Component	Description
1	Left speaker jacks	Connect the speaker to the main shelf system unit using the speaker wire to these jacks. Connect the red wire to the positive (+) jack and the black wire to the negative (-) jack.
2	Right speaker jacks	Connect the speaker to the main shelf system unit using the speaker wire to these jacks. Connect the red wire to the positive (+) jack and the black wire to the negative (-) jack.

Remote control

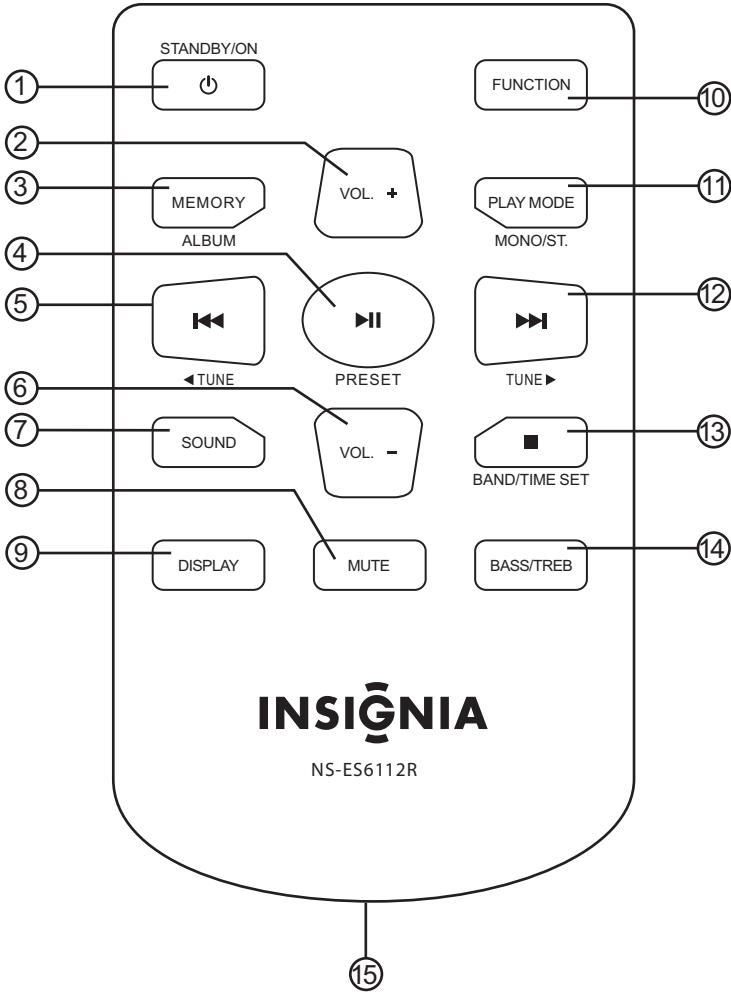

#	Button	Description
1	⏻ STANDBY/ON button	Press to turn your shelf system on. Press again to put your shelf system in standby mode.
2	VOL.+ / ▲ button	Press to increase the volume.

#	Button	Description
3	MEMORY/ALBUM button	In radio mode, press to store station presets. In MP3/WMA mode, press to go to the next album (folder). Press and hold to skip to the next track in an album.
4	▶ (play/pause)/PRESET button	In playback mode, press to begin playback. Press again to pause playback. Press again to resume playback. In radio mode, press to select a preset station.
5	◀◀ /TUNE ◀ button	In CD or iPod® mode, press to go to the previous track. Hold the button to fast reverse a track. In radio mode, press to seek the previous (lower frequency) radio station. Press and hold to tune to the next lower frequency with a good signal.
6	VOL.-/ ▼ button	Press to decrease the volume.
7	SOUND button	Press to select the preset equalizer mode.
8	MUTE button	Press to turn off the sound. Press again to turn the sound back on.
9	DISPLAY button	During playback, press to display the current time.
10	FUNCTION button	Press to select the play mode for your shelf system. Choices include AM, FM, CD, iPod®, or Line-in .
11	PLAY MODE/MONO/STEREO button	In CD playback mode, press to cycle through the repeat options. In FM stereo mode, press to select MONO or STEREO .
12	▶▶ /TUNE ▶ button	In CD or iPod® mode, press to go to the next track. Hold the button to fast forward a track. In radio mode, press to seek the next (higher frequency) radio station. Press and hold to tune to the next higher frequency with a good signal.
13	■ (stop)/BAND/TIME SET button	In playback mode, press to stop playback. In iPod® mode, press to pause playback. In radio mode, press to select AM or FM band. In standby mode, press to set the time.
14	BASS/TREB button	Press to adjust the Bass or Treble.
15	Battery tray	Remove tray, insert battery, then replace tray.

Using the remote control

- Aim the remote control at the IR sensor lens on the front of your shelf system from a distance of up to approximately 23 feet (7m) away.
- Make sure that there are no obstacles between the remote control sensor on your shelf system and the remote control.
- Direct sunlight, an incandescent or fluorescent lamp, or any strong light shining on the remote sensor may prevent the sensor from receiving signals from the remote control.

Setting up your shelf system

Installing the backup batteries

To install backup batteries:

- 1 Turn your shelf system over, then open the door of the battery compartment (1).

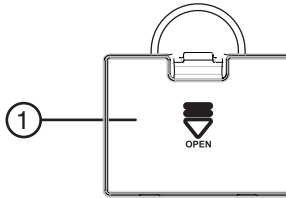

- 2 Insert two (2) AAA batteries into the battery compartment. Make sure that you match the + and - symbols on the batteries with the + and - symbols in the battery compartment.

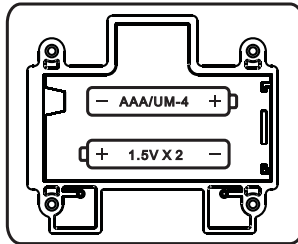

- 3 Reinstall and close the battery compartment and return your shelf system to the upright position.

Cautions:

Follow these precautions when using batteries in this device:

- Use only the size and type of batteries specified.
- Make sure that you follow the correct polarity as indicated in the battery compartment when installing batteries.
- Reversed batteries may cause damage to the shelf system.
- Do not mix different types of batteries together (for example, alkaline, rechargeable, and carbon zinc), or semi-used batteries with fresh ones.
- If your shelf system is not to be used for a long period of time, remove the batteries to prevent damage or injury from possible battery leakage.
- Do not try to recharge batteries not intended to be recharged, because they can overheat and rupture. (Follow battery manufacturer's directions.)
- Do not throw batteries into a fire. Dispose of used batteries as hazardous waste.

Notes

- The backup batteries are used to provide backup for your shelf system when AC power adapter is disconnected or there is a power failure.
- When the battery indicator  appears in the display, you need to replace the batteries.

Installing the remote control battery

Warning

There is a danger of explosion if the battery is not replaced correctly. Replace with the same or equivalent type battery.

To install the remote control battery:

- 1 Turn the remote control over to the back side.
- 2 Push the release tab to the right and pull the battery tray out of the remote control.

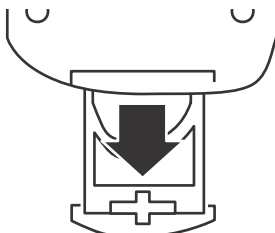

- 3 If this is the first time you will be using the remote control, remove the insulation sheet that covers the battery.

-OR-

If you are replacing the battery, remove the old battery and insert a new lithium coin cell battery (CR2025) into the battery tray. Make sure that you match the + symbol on the battery with the + and symbol on the battery tray.

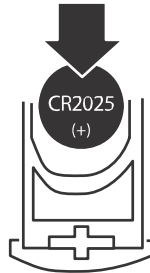

- 4 Slide the battery tray back into the remote control until it clicks into place.

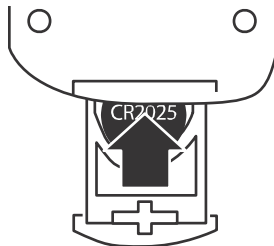

Warning

- Store the battery in a place where children cannot reach it. If a child accidentally swallows the battery, consult a doctor immediately.
- Do not recharge, short, disassemble, or heat the battery, or dispose of it in a fire. Doing any of these things may cause the battery to give off heat, crack, or start a fire.
- Do not leave the battery with other metallic materials. Doing this may cause the battery to give off heat, crack, or start a fire.
- When throwing away or saving the battery, wrap it in tape and insulate, otherwise, the battery may start to give off heat, crack, or start a fire.
- Dispose of battery in the proper manner, according to federal, state, and local regulations.
- If the remote control is not going to be used for an extended period of time, remove the battery.

Making connections

Connecting the AC adapter

Make sure that the AC power outlet matches the AC adapter's power specifications (100-240 V ~, 50/60 Hz) prior to plugging in the adapter.

To connect the AC adapter:

- 1 Complete all other connections.
- 2 Plug the small DC power connector into the DC IN jack on the back of your shelf system.
- 3 Connect one end of the AC power cord to the adapter, then plug the other end into an AC power outlet.

Note

Use only the AC adapter supplied with your shelf system, which has the following specifications: DC 12 V 3.33 A
Unplug the adapter from the power outlet when not in use.

Connecting the speakers

Your shelf system comes with two (2) speaker cables with bare, soldered wires at each end.

To connect the speakers:

- 1 Press the lever on the red (+) jack on the back of one speaker, then insert one end of the red speaker cable into the jack.
- 2 Press the lever on one of the red (+) jacks on the back of your shelf system, then insert the other end of the red speaker cable into the jack.
- 3 Repeat Step 1 and Step 2 to connect the black speaker cable to the black (-) jacks on the speaker and the back of your shelf system.
- 4 Repeat Steps 1 through 3 to connect the other speaker.

Connecting an iPod®

Your shelf system came with six iPod® holders. Make sure that you select the correct holder for the iPod® you are connecting. The holder number is engraved on the front of the holder.

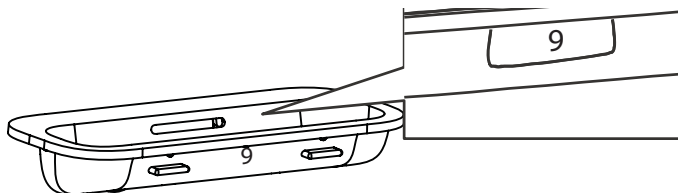

To connect an iPod® :

- 1 Select the appropriate iPod® dock adapter for your iPod®.

#	iPod® Models Supported	Capacity
9	5G iPod® with video	30 GB
	U2 iPod® with video	30 GB
	iPod® classic	80 GB, 120 GB
10	5G iPod® with video	60 and 80 GB
	iPod® classic	160 GB
11	iPod® Nano (2nd generation)	2, 4, and 8 GB
12	iPhone®	4 and 8 GB
13	iPod® Nano (3rd generation)	4 and 8 GB
14	iPod® Touch	8 and 16 GB

Notes

- iPod® dock adapter identification number is marked on the iPod® dock adapter.
- You can use the supplied dock adapter or your own adapter from Apple Inc.
- We recommend that you buy an appropriate dock adapter in case you lose one.

- 2 Make sure the shelf system and the iPod® are turned off.
- 3 Insert the iPod® into the dock adapter, then insert the dock adapter into the iPod® connector on the front of your shelf system. Press down gently on the dock adapter to make sure that the docking connector on the iPod® makes contact with the docking connector on the shelf system.

Note

- Always set the volume to the minimum when connecting or disconnecting other equipment.
- When you connect your iPod® to your shelf system, make sure you insert it all the way.

Connecting to an external sound source

You can listen to an external device, such as an MP3 player or other auxiliary device, through your shelf system speakers.

To listen to an external sound source:

- 1 Make sure that your shelf system is turned off.

- 2 Connect the **LINE OUT** jack on the external sound source to the **LINE IN** jack at the back panel of your shelf system using a stereo 3.5mm plug cord (not supplied).
- 3 Press **STANDBY/ON** to turn on your shelf system.
- 4 Turn the volume down.
- 5 Press the **FUNCTION** button repeatedly to select **Line in**. "LINE" appears on the LCD and sound from the external device is played through your shelf system's speakers.
- 6 Start playback on the external sound source, then adjust the volume to a comfortable level.

Using your shelf system

Before using your shelf system, make sure all connections are good, then plug the AC adapter into your shelf system and an AC power outlet.

Turning your shelf system on and off

To turn on your shelf system:

- 1 Press **STANDBY/ON**. Your shelf system turns on and starts playback in the last selected play mode.
- 2 Press **STANDBY/ON** again to switch your shelf system to standby mode.

Selecting the play mode

To select the play mode:

- Press **FUNCTION** repeatedly to cycle through the available play modes. Options include **iPod®**, **CD**, **Tuner** (radio), or **Line** (external device). The selected mode appears on the LCD.

Adjusting the volume

To adjust the volume:

- Press **VOL.+ / ▲** or **VOL.- / ▼** to increase or decrease the volume. **VOL** and the current volume setting appear on the display.
- Press **MUTE** to turn off the sound. Press **MUTE** or **VOL.+ / ▲** or **VOL.- / ▼** to turn the sound back on.

Setting the clock

To set the clock:

- 1 If your shelf system is on, press **STANDBY/ON** to switch your shelf system to standby mode.
- 2 Press the **/BAND/TIME SET** button on the front of your shelf system. **HOUR** starts blinking on the LCD.

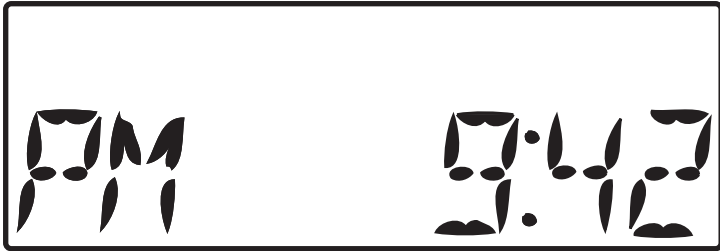

- 3 Press **▶▶ /TUNE+** or **◀◀ /TUNE-** repeatedly to set the hour.
- 4 Press the **/BAND/TIME SET** button again. **MIN** starts blinking on the LCD.
- 5 Press **▶▶ /TUNE+** or **◀◀ /TUNE-** repeatedly to set the minutes.
- 6 Press the **/BAND/TIME SET** button again to save the time setting and return to standby mode.

Playing an iPod®

To play an iPod®:

- 1 Connect the iPod® to your shelf system using one of the iPod® docks included with the system (see Connecting an iPod® on page 16).
- 2 Press **STANDBY/ON** to turn on your shelf system.
- 3 Turn the volume down.
- 4 Press the **FUNCTION** button to select **iPod®**. **iPod®** appears on the LCD and the iPod® starts playback.



- 5 Adjust the volume to a comfortable level.

Controlling iPod® playback

To control iPod® playback:

- Press ►|/PRESET to start or pause playback.
- Press ►►| /TUNE+ or |◄◄ /TUNE- to go to the next or previous iPod® track.
- Press and hold ►►| /TUNE+ or |◄◄ /TUNE- to search forward or backward on the iPod®.

Charging your iPod®

The iPod® is charged while it is set on your shelf system and your shelf system is powered on.

- Make sure that the AC adapter is providing power to your shelf system.
- The iPod® is charged regardless of the sound source selected on your shelf system.
- See your iPod® instruction manual about the details of iPod® charging.

Caution

- The connector plug is protected with a cover when it is first purchased. Please remove the cover before operating the shelf system.
- Do not carry the shelf system with your iPod® connected. You might drop it and damage the connector.
- Do not touch or hit the iPod® terminal pins or the connector pins directly. It might cause damage to the connector part.
- If the iPod® does not play correctly, please update your iPod® software to the latest version. - For details about updating your iPod®, check on the Apple web site: <<http://www.apple.com>>.
- iPod® is a trademark of Apple Inc., registered in the U.S. and other countries.
- We are not responsible for any loss of or damage to your iPod® that might result from the use of this product.
- Sound distortion may occur when playing back audio sources with high recording levels. When distortion occurs, we recommend that you turn off the iPod® equalizer. For information on operating the iPod®, see the iPod® instruction manual.

Playing a disc

Your shelf system can play audio CD, CD-R, and CD-RW discs, and MP3 and WMA files.

To play a disc:

- 1 Press ⏻ STANDBY/ON to turn on your shelf system.

- Slide the **CD OPEN/CLOSE** switch to open the CD compartment. **OPEN** appears on the LCD.



- Insert a CD with the label facing toward the front of your shelf system, then close the door. **READ** appears on the LCD.

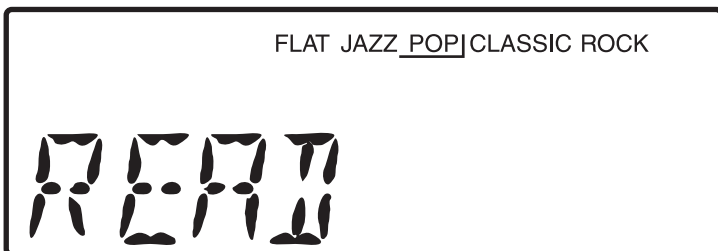

- Press **FUNCTION** to select **CD**. Playback starts automatically.

Controlling disc playback

To control disc playback:

- Press **▶||/PRESET** on the remote control or the shelf system to start or pause playback.
- Press **▶▶|/TUNE+** or **|◀◀/TUNE-** to go to the next or previous track, or hold to search forward or reverse.
- Press **■/BAND/TIME SET** to stop playback. When playback is resumed, it starts from the beginning of the disc.
- (MP3/WMA only) Press and hold **MEMORY/ALBUM** to skip to the next album and play the first track.
- (MP3/WMA only) Press **MEMORY/ALBUM** to skip forward one track at a time. When you reach the end of an album, your shelf system skips to the first track on the next album.
- Press **MODE** one or more times to select a playback mode. The corresponding icon appears on the LCD. You can select:
 - One Repeat Play**—Repeats the track you are playing
 - Repeat Album**—(MP3/WMA only) Repeats the currently playing album

- **All Repeat Play**—Repeats the entire disc
- **Intro Play**—Plays the first 10 seconds of each track
- **Random Play**—Plays all tracks in random order

Playing the radio

To play the radio:

- 1 Press **STANDBY/ON** to turn on your shelf system, then press **FUNCTION** to select **TUNER**.
- 2 Press **/BAND/TIME SET** to select **FM** or **AM**. The corresponding band appears on the LCD.
- 3 Press **/TUNE+** or **/TUNE-** to select a frequency.
- 4 Press and hold **/TUNE+** or **/TUNE-** for two seconds to automatically go to the next higher or lower frequency with a strong signal.
- 5 In FM mode, press **PLAY MODE** to select **FM MONO** or **FM STEREO**.
- 6 If you are listening to FM, stretch out the FM antenna on the back of your shelf system and move it around to improve reception.
-OR-
If you are listening to AM, try turning your shelf system for better reception.
- 7 Adjust the volume to a comfortable level.

Storing radio station presets

Your shelf system can store 10 AM and 10 FM station presets.

To store radio station presets:

- 1 Press **STANDBY/ON** to turn on your shelf system, then press **FUNCTION** to select **TUNER**.
- 2 Press **/BAND/TIME SET** to select **FM** or **AM**. The corresponding band appears on the LCD.
- 3 Press **/TUNE+** or **/TUNE-** to select a frequency.
- 4 Press **MEMORY/ALBUM** to save the station as a preset. **PRESET** and **01** appears on the LCD.

- 5 Press **▶▶| /TUNE+** or **|◀◀ /TUNE-** to select the preset number (1 to 10) that you want to assign to the station preset.

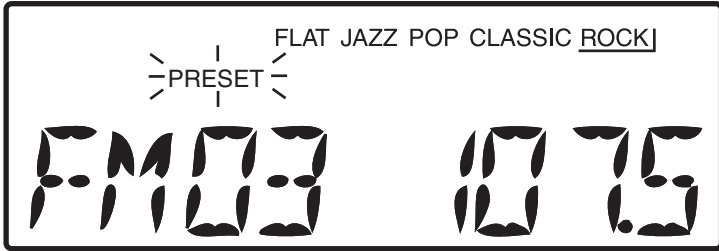

- 6 Press **MEMORY/ALBUM** to save the station preset.

Changing a radio station preset frequency

To change a radio station preset:

- 1 Press **⏻ STANDBY/ON** to turn on your shelf system, then press **FUNCTION** to select **TUNER**.
- 2 Press **■ /BAND/TIME SET** to select **FM** or **AM**. The corresponding band appears on the LCD.
- 3 Press **MEMORY/ALBUM**. **PRESET** blinks on the LCD for five seconds, the preset frequency appears on the LCD, and your shelf system tunes to the station preset.
- 4 Press **▶▶| /TUNE+** or **|◀◀ /TUNE-** to tune to another preset while **PRESET** is blinking.
- OR -
Press **▶▶| /PRESET** repeatedly to select the preset number (1 to 10).

Playing from an external device

To play from an external device:

- 1 Make sure that an external device is connected to your shelf system. For more information, see "Connecting to an external sound source" on page 17.

- 2 Turn on your shelf system, then press **FUNCTION** to select **LINE**. Sound from the device plays through your shelf system's speakers.



Selecting the equalizer mode

To select the equalizer mode:

- With your shelf system on, press **EQ** repeatedly to cycle through the available modes. You can select **FLAT**, **JAZZ**, **POP**, **CLASSIC**, or **ROCK**.

Adjusting the bass and treble

To adjust the bass and treble:

- 1 With your shelf system on, press **BASS/TREB**. The current bass setting appears on the LCD.

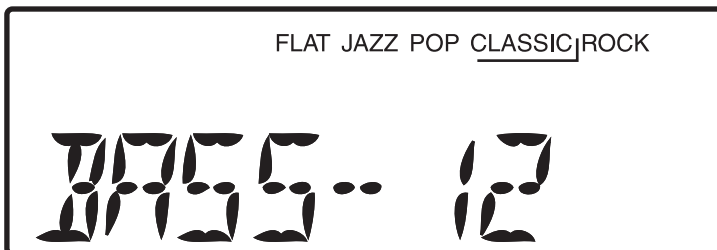

- 2 Press **▶▶| /TUNE+** or **|◀◀ /TUNE-** to adjust the bass. You can choose settings from -14 dB to +14 dB.

- 3 Press **BASS/TREB** again. **TREBLE** and the current treble setting appear on the LCD.



- 4 Press **▶▶ /TUNE+** or **◀◀ /TUNE-** to adjust the treble. You can choose settings from -14 dB to +14 dB.

Displaying the time during playback

To display the time during playback:

- Press **DISPLAY** in **iPod®**, **CD**, **TUNER**, or **LINE IN** mode. The shelf system shows the current time on the LCD until you press **DISPLAY** again.

Troubleshooting

Problem	Cause/Solution
No power	<ul style="list-style-type: none"> • Make sure that the AC power adapter is fully inserted into the AC power outlet.
The remote control does not work	<ul style="list-style-type: none"> • The batteries may be dead. Change the batteries. • The remote control is not aimed at the remote control sensor on the shelf system. Aim the remote control directly at the shelf system when you push the buttons.
Cannot connect an iPod®	<ul style="list-style-type: none"> • Make sure that the dock adapter you selected is compatible with your iPod®. • Make sure that the dock adapter is correctly mounted on the shelf system.
Cannot play an iPod®	<ul style="list-style-type: none"> • Make sure that the iPod® is firmly inserted into the iPod® connector on your shelf system. • Make sure that the iPod® is working. Test it before trying to connect it to the shelf system. • Make sure iPod® mode is selected.

Problem	Cause/Solution
Cannot charge an iPod®	<ul style="list-style-type: none"> • Make sure that the iPod® is firmly inserted into the iPod® connector on your shelf system. • Make sure that the AC adapter is plugged in and firmly connected to the DC IN port on your shelf system.
CD does not play or sound is intermittent	<ul style="list-style-type: none"> • Make sure that the disc is inserted correctly. • Make sure that the disc is not dirty or defective. • Make sure the pickup lens is not dirty. • If moisture or condensation has accumulated inside your shelf system, let your shelf system warm up for 60 minutes so the liquid evaporates. • The disc may not be compatible with your shelf system. • Make sure that the CD door is completely closed. • If you are using headphones, make sure they are connected securely. • Make sure that CD mode is selected.
No sound from the speakers	<ul style="list-style-type: none"> • Make sure that the volume level is set correctly. • Make sure that the sound is not muted. • Make sure that the headphones are not connected.
The system does not respond when buttons are pressed	<ul style="list-style-type: none"> • Remove and reconnect the AC power plug and switch on the system again.
Static or noise when playing the radio	<ul style="list-style-type: none"> • Make sure that the station is tuned correctly and that the station has a good signal. • Try another station. • If you are playing an AM station, rotate the shelf system to improve the reception. • If you are playing an FM station, extend the antenna wire to improve the reception.
No sound from the external audio device	<ul style="list-style-type: none"> • Make sure that the device is firmly connected to the shelf system. • Make sure that the shelf system is set to LINE IN mode. • Make sure that the device is not locked by its HOLD button.

Maintaining

Cleaning discs

A dirty disc may not play correctly.

To clean a disc:

- With a soft cloth, wipe the disc in a straight line from the center to the edge.

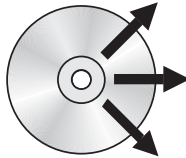

Caution

Do not use any solvent, such as record spray, thinner, or benzene, to clean a disc.

Cleaning your shelf system

To clean your shelf system, follow these guidelines:

- Use a soft, clean dry cloth to clean the exterior of your shelf system.
- Do not let liquid drip into the inside of your shelf system.
- For stubborn stains, use a soft cloth dampened with a weak solution of mild detergent and water. Dry your shelf system immediately afterwards with a clean cloth. Do not use abrasive clothes, thinners, alcohol, or other chemical solvents, because they may damage the finish or remove the panel lettering.

Cleaning the pickup lens

To clean the pickup lens:

- 1 Open the CD door.
- 2 Use a camera lens brush/blower to blow dirt off the lens, then brush the lens to remove dirt and dust.

Specifications

Specifications are subject to change without notice.

CD/MP3/WMA

Disc support	5-inch and 3-inch CD-R or CD-RW discs compatible with CD/MP3, WMA formats
Electrical shock protection	CD - 10 seconds MP3 - 120 seconds WMA - 40 seconds
Multi-session support	For MP3 and ISO9660 format
Converter	1-bit D/A
Over-sampling	8 times
File support	Folder (album) - 99 File (track) - 999

Digital tuner

Frequency range	FM - 87.5~107.9 MHz (200 K Hz steps) AM - 530~1710 KHz (10 KHz steps)
Presets	FM - 10 AM - 10

External connections

Headphone output	3.5 mm stereo
Line input	3.5 mm stereo
iPod® connector	30-pin standard type
Speaker output	Speaker wire terminals
FM antenna input	Clip (wire) type

Other

Electrical volume	32-step control (maximum)
Display	Full-digit LCD
Audio output	10 W RMS x2
External speaker system	2 speakers (L/R), 4 Ohm woofer with tweeter
Power source	DC IN 12 V 3.33 A adapter (center positive)

Legal notices

FCC Part 15

This device complies with Part 15 of the FCC Rules. Operation of this product is subject to the following two conditions: (1) this device may not cause harmful interference, and (2) this device must accept any interference received, including interference that may cause undesired operation.

This equipment has been tested and found to comply within the limits for a class B digital device, pursuant to Part 15 of the FCC Rules. These limits are designed to provide reasonable protection against harmful interference in a residential installation. This equipment generates, uses, and can radiate radio frequency energy and, if not installed and used in accordance with the instructions, may cause harmful interference to radio communications. However, there is no guarantee that interference will not occur in a particular installation. If this equipment does cause harmful interference to radio or television reception, which can be determined by turning the equipment off and on, the user is encouraged to try to correct the interference by one or more of the following measures:

- Reorient or relocate the receiving antenna.
- Increase the separation between the equipment and receiver.
- Connect the equipment into an outlet on a circuit different from that to which the receiver is connected.
- Consult the dealer or an experienced radio/TV technician for help.

FCC warning

Changes or modifications not expressly approved by the party responsible for compliance with the FCC Rules could void the user's authority to operate this equipment.

Energy Star

Products that have earned ENERGY STAR® are designed to protect the environment through superior energy efficiency. Your player is Energy Star compliant.



One-year limited warranty

Insignia Products ("Insignia") warrants to you, the original purchaser of this new **NS-ES6112** ("Product"), that the Product shall be free of defects in the original manufacture of the material or workmanship for a period of one (1) year from the date of your purchase of the Product ("Warranty Period"). This Product must be purchased from an authorized dealer of Insignia brand products and packaged with this warranty statement. This warranty does not cover refurbished Product. If you notify Insignia during the Warranty Period of a defect covered by this warranty that requires service, terms of this warranty apply.

How long does the coverage last?

The Warranty Period lasts for 1 year (365 days) from the date you purchased the Product. The purchase date is printed on the receipt you received with the Product.

What does this warranty cover?

During the Warranty Period, if the original manufacture of the material or workmanship of the Product is determined to be defective by an authorized Insignia repair center or store personnel, Insignia will (at its sole option): (1) repair the Product with new or rebuilt parts; or (2) replace the Product at no charge with new or rebuilt comparable products or parts. Products and parts replaced under this warranty become the property of Insignia and are not returned to you. If service of Products or parts are required after the Warranty Period expires, you must pay all labor and parts charges. This warranty lasts as long as you own your Insignia Product during the Warranty Period. Warranty coverage terminates if you sell or otherwise transfer the Product.

How to obtain warranty service?

If you purchased the Product at a retail store location, take your original receipt and the Product to the store you purchased it from. Make sure that you place the Product in its original packaging or packaging that provides the same amount of protection as the original packaging. If you purchased the Product from an online web site, mail your original receipt and the Product to the address listed on the web site. Make sure that you put the Product in its original packaging or packaging that provides the same amount of protection as the original packaging.

To obtain in-home warranty service for a television with a screen 25 inches or larger, call 1-888-BESTBUY. Call agents will diagnose and correct the issue over the phone or will have an Insignia-approved repair person dispatched to your home.

Where is the warranty valid?

This warranty is valid only to the original purchaser of the product in the United States, Canada, and Mexico.

What does the warranty not cover?

This warranty does not cover:

- Customer instruction
- Installation
- Set up adjustments
- Cosmetic damage
- Damage due to acts of God, such as lightning strikes
- Accident
- Misuse
- Abuse
- Negligence
- Commercial use
- Modification of any part of the Product, including the antenna

- Plasma display panel damaged by static (non-moving) images applied for lengthy periods (burn-in).

This warranty also does not cover:

- Damage due to incorrect operation or maintenance
- Connection to an incorrect voltage supply
- Attempted repair by anyone other than a facility authorized by Insignia to service the Product
- Products sold as is or with all faults
- Consumables, such as fuses or batteries
- Products where the factory applied serial number has been altered or removed

REPAIR REPLACEMENT AS PROVIDED UNDER THIS WARRANTY IS YOUR EXCLUSIVE REMEDY. INSIGNIA SHALL NOT BE LIABLE FOR ANY INCIDENTAL OR CONSEQUENTIAL DAMAGES FOR THE BREACH OF ANY EXPRESS OR IMPLIED WARRANTY ON THIS PRODUCT, INCLUDING, BUT NOT LIMITED TO, LOST DATA, LOSS OF USE OF YOUR PRODUCT, LOST BUSINESS OR LOST PROFITS. INSIGNIA PRODUCTS MAKES NO OTHER EXPRESS WARRANTIES WITH RESPECT TO THE PRODUCT, ALL EXPRESS AND IMPLIED WARRANTIES FOR THE PRODUCT, INCLUDING, BUT NOT LIMITED TO, ANY IMPLIED WARRANTIES OF AND CONDITIONS OF MERCHANTABILITY AND FITNESS FOR A PARTICULAR PURPOSE, ARE LIMITED IN DURATION TO THE WARRANTY PERIOD SET FORTH ABOVE AND NO WARRANTIES, WHETHER EXPRESS OR IMPLIED, WILL APPLY AFTER THE WARRANTY PERIOD. SOME STATES, PROVINCES AND JURISDICTIONS DO NOT ALLOW LIMITATIONS ON HOW LONG AN IMPLIED WARRANTY LASTS, SO THE ABOVE LIMITATION MAY NOT APPLY TO YOU. THIS WARRANTY GIVES YOU SPECIFIC LEGAL RIGHTS, AND YOU MAY ALSO HAVE OTHER RIGHTS, WHICH VARY FROM STATE TO STATE OR PROVINCE TO PROVINCE.

Contact Insignia:

For customer service please call 1-877-467-4289
www.insigniaproducts.com

Distributed by Best Buy Purchasing, LLC
7601 Penn Avenue South, Richfield, Minnesota, U.S.A. 55423-3645
© 2009 Best Buy Enterprise Services, Inc.

All rights reserved. INSIGNIA is a trademark of Best Buy Enterprise Services, Inc. Registered in some countries. All other products and brand names are trademarks of their respective owners.



www.insigniaproducts.com (877) 467-4289

Distributed by Best Buy Purchasing, LLC
7601 Penn Avenue South, Richfield, MN USA 55423-3645

© 2009 Best Buy Enterprise Services, Inc.

All rights reserved. INSIGNIA is a trademark of Best Buy Enterprise Services, Inc.

Registered in some countries.

All other products and brand names are trademarks of their respective owners.